



UNIVERSITY OF CAMBRIDGE INTERNATIONAL EXAMINATIONS
General Certificate of Education Ordinary Level

CANDIDATE
NAME

CENTRE
NUMBER

--	--	--	--	--

CANDIDATE
NUMBER

--	--	--	--



MATHEMATICS (SYLLABUS D)

4024/22

Paper 2

May/June 2013

2 hours 30 minutes

Candidates answer on the Question Paper.

Additional Materials: Geometrical instruments
 Electronic calculator

READ THESE INSTRUCTIONS FIRST

Write your Centre number, candidate number and name on all the work you hand in.

Write in dark blue or black pen.

You may use a pencil for any diagrams or graphs.

Do not use staples, paper clips, highlighters, glue or correction fluid.

DO NOT WRITE IN ANY BARCODES.

Section A

Answer **all** questions.

Section B

Answer any **four** questions.

If working is needed for any question it must be shown in the space below that question.

Omission of essential working will result in loss of marks.

You are expected to use an electronic calculator to evaluate explicit numerical expressions.

If the degree of accuracy is not specified in the question, and if the answer is not exact, give the answer to three significant figures. Give answers in degrees to one decimal place.

For π , use either your calculator value or 3.142, unless the question requires the answer in terms of π .

The number of marks is given in brackets [] at the end of each question or part question.

The total of the marks for this paper is 100.

This document consists of **23** printed pages and **1** blank page.



Section A [52 marks]Answer **all** questions in this section.For
Examiner's
Use**1 (a) (i)**

Exchange rate
 $\text{£}1 = \$2.06$
 $\text{£}1 = 72 \text{ rupees}$

Manraj changes 25 200 rupees into dollars (\$).

Calculate how many dollars he receives.

Answer \$..... [2]

(ii) Misja changes 380 euros into dollars (\$).
He receives \$551.

How many dollars does he receive for each euro?

Answer 1 euro = \$ [1]

(b)

Account	Simple interest per year
Super Saver	3.4%
Extra Saver	3.5%

On 31 March 2011, Lydia and Simone each had \$8000 in an account. Lydia's money is in a Super Saver Account. Simone's money is in an Extra Saver Account.

- (i) How much money did Lydia have in her account on 31 March 2012 after the interest had been added?

Answer \$..... [2]

- (ii) On 31 March 2012, Lydia transferred this money to an Extra Saver Account. How much money did she have in this account on 31 March 2013 after the interest had been added?

Answer \$..... [1]

- (iii) Simone kept her money for the two years in the Extra Saver Account, which earned simple interest of 3.5% per year. After all interest had been added, who had more money in their account on 31 March 2013 and by how much?

Answer had \$ more [2]

- 2 Small triangles are formed by placing rods between dots as shown in the diagrams.

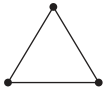

Diagram 1

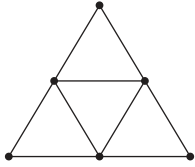

Diagram 2

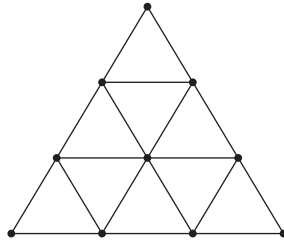

Diagram 3

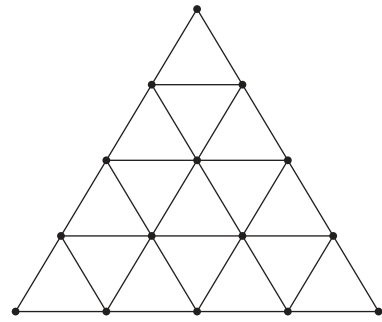

Diagram 4

- (a) Complete the table.

Diagram n	1	2	3	4	5
Number of small triangles (T)	1	4	9	16	
Number of dots (D)	3	6	10	15	
Number of rods (R)	3	9	18	30	

[2]

- (b) Find an expression, in terms of n , for the number of small triangles (T) formed in Diagram n .

Answer [1]

- (c) Given that $R = D + T - 1$, find the value of n when $D = 561$ and $R = 1584$.

Answer $n =$ [2]

(d) 1, 3, 6, 10, 15,

The n th term of the above sequence is $\frac{1}{2}n(n+1)$.

Hence find an expression for R in terms of n .

For
Examiner's
Use

Answer [1]

(e) How many rods are there in Diagram 15?

Answer [1]

(f) Find an expression for D in terms of n .

Answer [2]

3 (a) Solve $3(x - 5) = 5x - 7$.

Answer $x = \dots\dots\dots$ [2]

(b) (i) Solve $\frac{4y - 3}{2} \leq 7$.

Answer $\dots\dots\dots$ [2]

(ii) State the integers that satisfy both $\frac{4y - 3}{2} \leq 7$ and $y > 2$.

Answer $\dots\dots\dots$ [1]

(c) Solve the simultaneous equations.

$$\begin{aligned} 2x - y &= 6 \\ 4x + 3y &= -3 \end{aligned}$$

Answer $x = \dots\dots\dots$

$y = \dots\dots\dots$ [3]

- 4 $ABCDEF$ is a hexagon with BE as its only line of symmetry.

For
Examiner's
Use

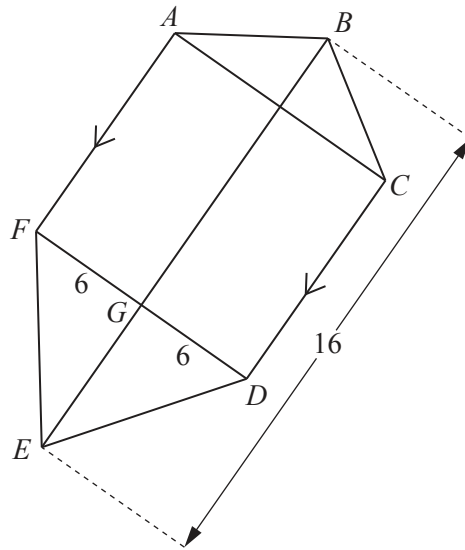

AF is parallel to CD and DF intersects BE at G .
 $BE = 16$ cm and $DG = GF = 6$ cm.
 The area of the hexagon $ABCDEF$ is 138 cm².

- (a) Calculate AF .

Answer cm [2]

- (b) The area of the hexagon $ABCDEF$ is four times the area of the triangle DEF .

- (i) Find EG .

Answer cm [2]

- (ii) Find $EG : GB$, giving your answer in the form $m : n$ where m and n are integers.

Answer : [2]

5

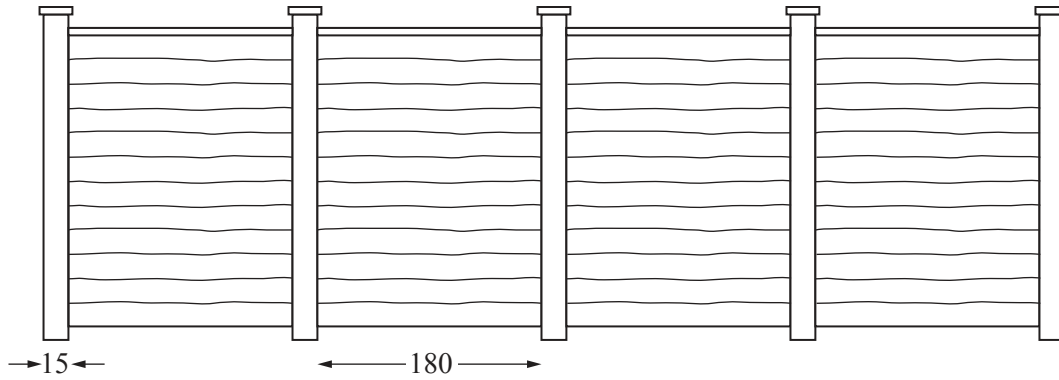

Mr Chan wants a fence along the side of his garden which is 8 metres long.
 He buys 4 fence panels and 5 posts.
 Each fence panel is 180 cm wide, correct to the nearest centimetre.
 Each post is 15 cm wide, correct to the nearest centimetre.

- (a) If there are no gaps between the panels and the posts, is it possible for the fence to be longer than 8 metres?
 Show your working.

[2]

- (b) A shop buys the posts from a manufacturer and sells them at a profit of 30%.
 The shop sells each post for \$35.10.

- (i) How much does each post cost from the manufacturer?

Answer \$..... [2]

(ii)

Fence panels	\$50.70 each
Posts	\$35.10 each

*For
Examiner's
Use*

Mr Chan buys 4 fence panels and 5 posts.

He hires a builder to put up the fence.

The builder charges 220% of the total cost of the fence panels and posts to do the work.

What is the total amount Mr Chan pays for his fence?

Answer \$..... [3]

6 The diagram shows the positions, P , Q , R and S , of four hotels.

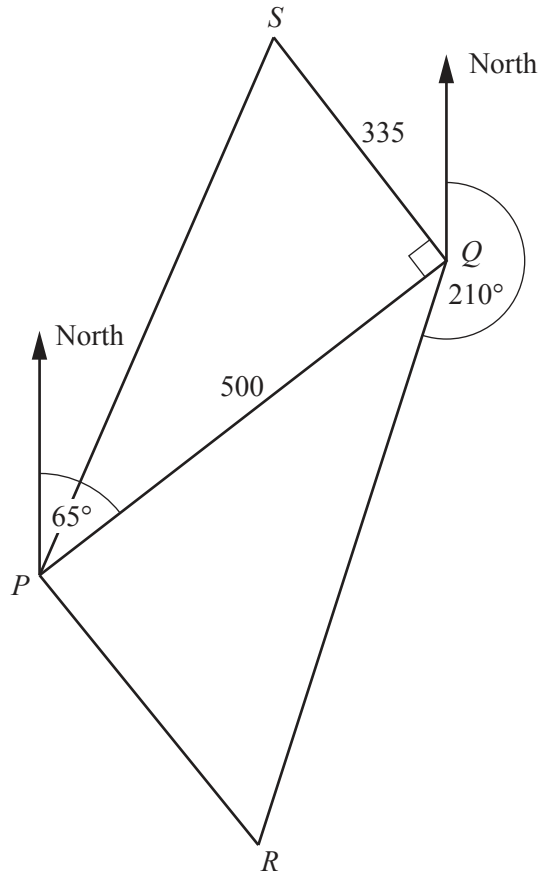

The bearing of Q from P is 065° and the bearing of R from Q is 210° .
 $PQ = 500$ m, $SQ = 335$ m and $\angle PQS = 90^\circ$.

(a) Calculate $\angle PQR$.

Answer [1]

(b) Calculate the shortest distance from P to QR .

Answer m [2]

(c) Calculate the bearing of S from P .

*For
Examiner's
Use*

Answer [3]

- 7 (a) The distribution of the times spent by 200 customers at a restaurant one evening is shown in the table.

For
Examiner's
Use

Time (t minutes)	$30 \leq t < 60$	$60 \leq t < 80$	$80 \leq t < 90$	$90 \leq t < 100$	$100 \leq t < 120$
Frequency	24	p	q	58	28

The diagram shows part of the histogram that represents this data.

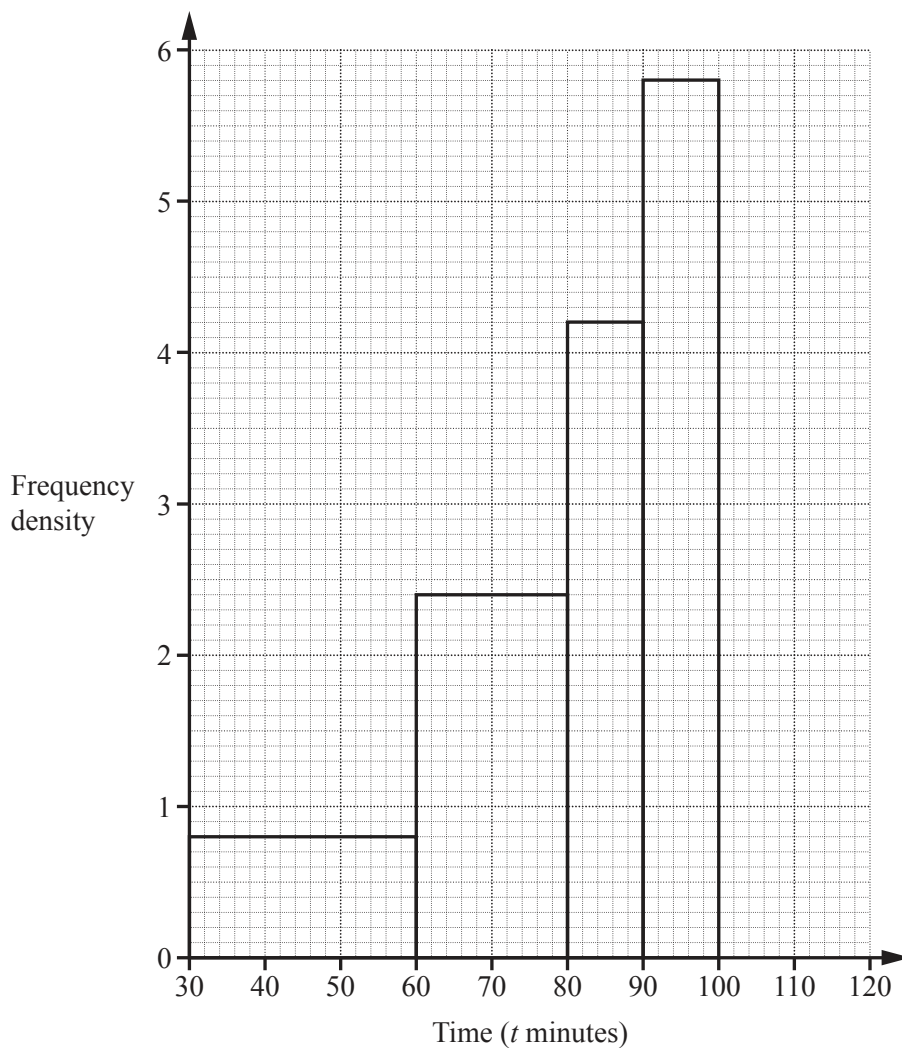

- (i) Complete the histogram. [1]
- (ii) Find p and q .

Answer $p = \dots\dots\dots$

$q = \dots\dots\dots$ [2]

- (iii) Estimate the probability that a customer, chosen at random, spent more than 95 minutes in the restaurant.

Answer $\dots\dots\dots$ [1]

(b) The table below shows the distribution of the ages of these customers.

Age (y years)	$0 < y \leq 20$	$20 < y \leq 40$	$40 < y \leq 60$	$60 < y \leq 80$
Frequency	34	57	85	24

For
Examiner's
Use

(i) State the modal class.

Answer [1]

(ii) Calculate an estimate of the mean age of these customers.

Answer years [3]

Section B [48 marks]

Answer **four** questions in this section.

Each question in this section carries 12 marks.

*For
Examiner's
Use*

- 8** The scale diagram shows the positions, *A* and *B*, of two buoys.
B is due South of *A* and $AB = 1500$ m.



- (a)** Write down the scale of the diagram.

Answer 1 cm tom [1]

- (b)** A third buoy is positioned at *C* which is due East of *B* and 1800 m from *A*.

Mark the position of *C* on the diagram. [2]

- (c)** **Calculate** the actual distance *BC*.
Give your answer correct to the nearest metre.

Answerm [2]

- (d) A boat travels from C to A at an average speed of x m/s.
 A second boat travels from B to A at an average speed 1 m/s faster than the first boat.
 It takes the first boat 1 **minute** longer to reach A than the second boat.

For
Examiner's
Use

Write down an equation in x and show that it simplifies to $x^2 - 4x - 30 = 0$.

[3]

- (e) Solve $x^2 - 4x - 30 = 0$, giving each answer correct to two decimal places.

Answer $x = \dots\dots\dots$ or $\dots\dots\dots$ [3]

- (f) How long did it take the first boat to reach A ?
 Give your answer in seconds.

Answer $\dots\dots\dots$ seconds [1]

9 (a) $ABCD$ is a parallelogram.

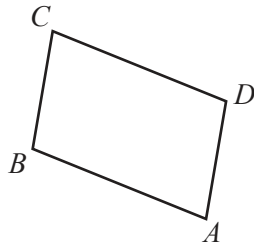

$$\vec{AB} = \begin{pmatrix} -4 \\ 2 \end{pmatrix} \text{ and } \vec{BC} = \begin{pmatrix} 1 \\ 4 \end{pmatrix}.$$

(i) Find \vec{BD} .

Answer $\left(\begin{array}{c} \\ \end{array} \right)$ [1]

(ii) Calculate $|\vec{AC}|$.

Answer [2]

(iii) The parallelogram $ABCD$ is mapped onto the parallelogram $PBQR$.

$$\vec{PB} = \begin{pmatrix} -12 \\ 6 \end{pmatrix} \text{ and } \vec{BQ} = \begin{pmatrix} 3 \\ 12 \end{pmatrix}.$$

(a) Describe fully the **single** transformation that maps the parallelogram $ABCD$ onto the parallelogram $PBQR$.

Answer

..... [2]

(b) S is the midpoint of PQ .

Find \vec{SR} .

For
Examiner's
Use

Answer $\left(\quad \right)$ [2]

(b)

$$f(x) = \frac{3x + 2}{5}$$

Find

(i) $f(-4)$,

Answer $f(-4) = \dots\dots\dots$ [1]

(ii) the value of g such that $f(g) = 7$,

Answer $g = \dots\dots\dots$ [2]

(iii) $f^{-1}(x)$.

Answer $f^{-1}(x) = \dots\dots\dots$ [2]

- 10 (a) A bag contains red and blue pegs. Altogether there are 25 pegs of which n are red. Rashid picks two pegs without replacement. The tree diagram shows the possible outcomes and their probabilities.

For
Examiner's
Use

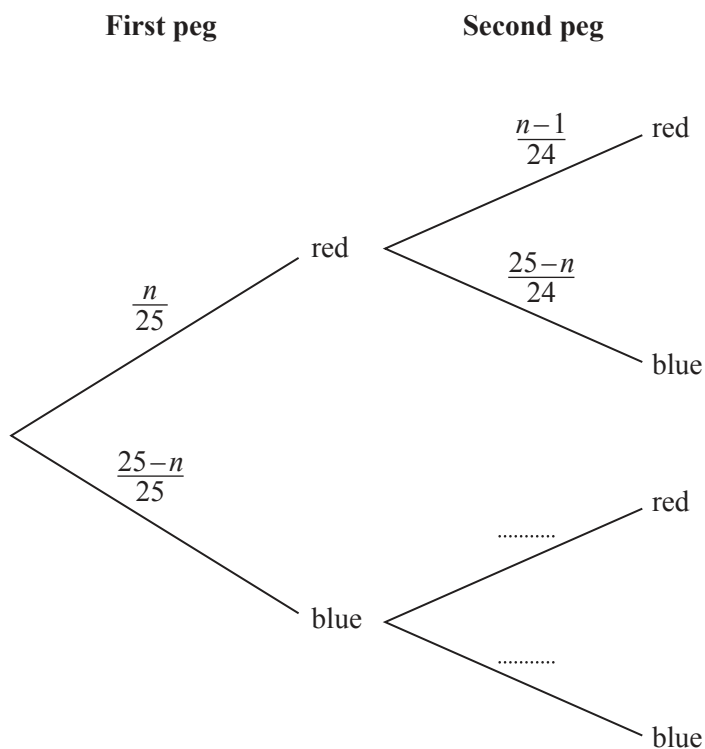

- (i) Complete the tree diagram. [2]
- (ii) (a) Write an expression, as a single fraction in terms of n , for the probability that Rashid picks a red peg then a blue peg in that order.

Answer [1]

- (b) The probability that Rashid picks a red peg then a blue peg in that order is $\frac{1}{p}$.

Given that the number of red pegs, n , satisfies the equation $n^2 - 25n + 150 = 0$, find p .

Answer $p =$ [2]

(iii) Solve $n^2 - 25n + 150 = 0$ to find the possible values of n .

Answer $n = \dots\dots\dots$ or $\dots\dots\dots$ [2]

(iv) Given that at the start there are more blue pegs than red pegs in the bag, find the probability that Rashid picks two red pegs.

Answer $\dots\dots\dots$ [2]

(b) Each member of a group of children was asked their favourite colour. The pie chart represents the results.

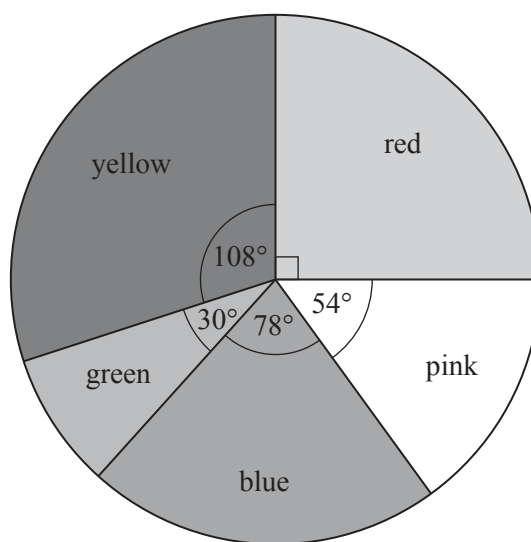

(i) The number of children whose favourite colour is red is 75. Find the number of children in the group.

Answer $\dots\dots\dots$ [1]

(ii) Find, in its simplest form, the fraction of children whose favourite colour is green.

Answer $\dots\dots\dots$ [1]

(iii) How many more children answered yellow than answered blue?

Answer $\dots\dots\dots$ [1]

11 (a) The table shows some values of x and the corresponding values of y for $y = 2x^3 - 3x^2 + 5$.

x	-1.5	-1	-0.5	0	0.5	1	1.5	2
y		0	4	5	4.5	4	5	9

(i) Complete the table. [1]

(ii) Using a scale of 4 cm to represent 1 unit, draw a horizontal x -axis for $-1.5 \leq x \leq 2$.
Using a scale of 2 cm to represent 5 units, draw a vertical y -axis for $-10 \leq y \leq 10$.

Draw the graph of $y = 2x^3 - 3x^2 + 5$ for $-1.5 \leq x \leq 2$. [3]

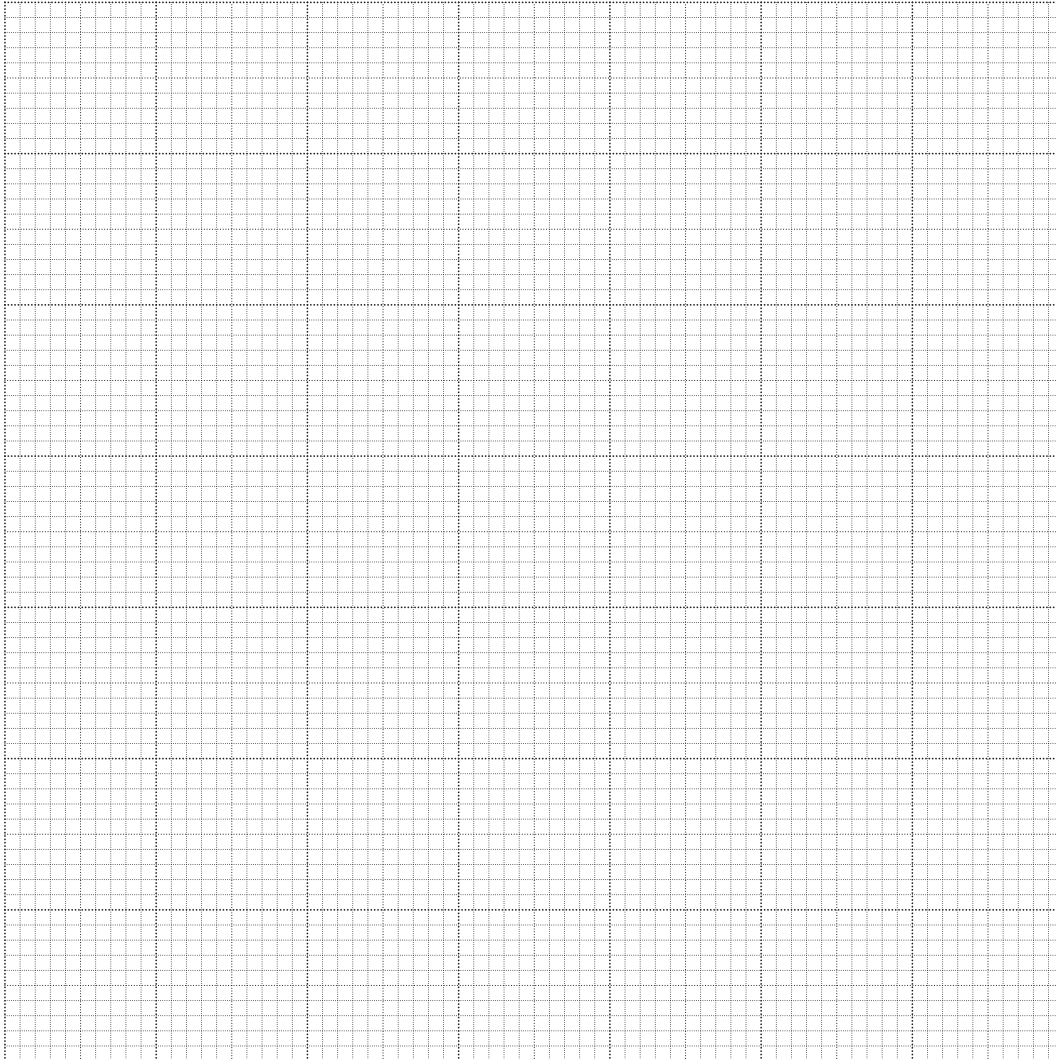

(iii) Use your graph to estimate the gradient of the curve when $x = 1.5$.

Answer [2]

(iv) By drawing a suitable line on your graph, find the solution of the equation $2x^3 - 3x^2 + 4 = 0$.

Answer $x =$ [2]

(b)

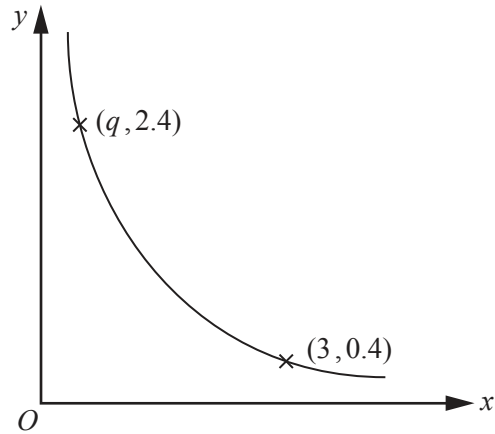

The graph shows a sketch of the curve $y = \frac{p}{x}$.
Two points on the curve are $(3, 0.4)$ and $(q, 2.4)$.

(i) Find p and q .

Answer $p = \dots\dots\dots$

$q = \dots\dots\dots$ [2]

(ii) Calculate the gradient of the straight line joining the points $(3, 0.4)$ and $(q, 2.4)$.

Answer $\dots\dots\dots$ [2]

12 (a)

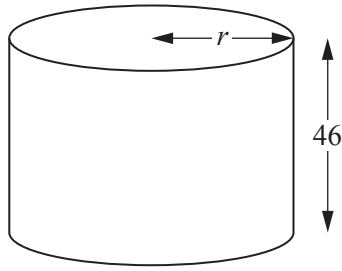

A cylindrical tank of height 46 cm and radius r cm has a capacity of 70 litres.

Find the radius correct to the nearest centimetre.

Answer cm [3]

(b)

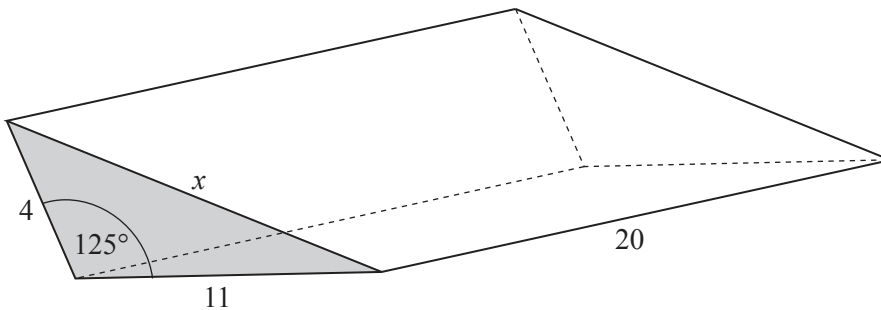

A triangular prism has length 20 cm.

The sides of the shaded cross-section are 4 cm, 11 cm and x cm.

The angle between the sides of length 4 cm and 11 cm is 125° .

(i) Calculate the area of the shaded cross-section.

Answercm² [2]

(ii) Calculate the volume of the prism.

Answercm³ [1]

(iii) Calculate x .

Answer $x =$ [4]

(iv) Calculate the surface area of the prism.

Answercm² [2]

BLANK PAGE

Permission to reproduce items where third-party owned material protected by copyright is included has been sought and cleared where possible. Every reasonable effort has been made by the publisher (UCLES) to trace copyright holders, but if any items requiring clearance have unwittingly been included, the publisher will be pleased to make amends at the earliest possible opportunity.

University of Cambridge International Examinations is part of the Cambridge Assessment Group. Cambridge Assessment is the brand name of University of Cambridge Local Examinations Syndicate (UCLES), which is itself a department of the University of Cambridge.